

HCT01

Humidity / Temperature Sensor

HCT01 humidity/temperature sensors combine high quality, long time approved thin-film sensor technology simple processability and the possibility of a cost-efficient integration into customer application.

The pre-adjusted capacitive E+E humidity sensor element saves complicated and time-consuming humidity adjustment. Highly accurate thin-film elements are used for the temperature measurement – a must for precise dew point determination.

The DFN packaging guarantees maximum mechanical sensor protection and enables reflow soldering. A protective film on the surface of the humidity sensor ensures extensive protection against contamination like dust, salt or chemical deposit.

Depending on the individual application, accuracy requirements and existing interface electronics, different cost-saving evaluation circuitries are available. Do not hesitate to contact our specialists for further information and design-in support.

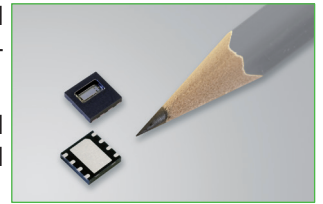

Features

- RH and T sensor in one package**
- RH adjusted**
- mature humidity sensor technology**
- high temperature accuracy**
- reflow solderable**
- integrated dust filter**
- standardized DFN package**

Basic Design

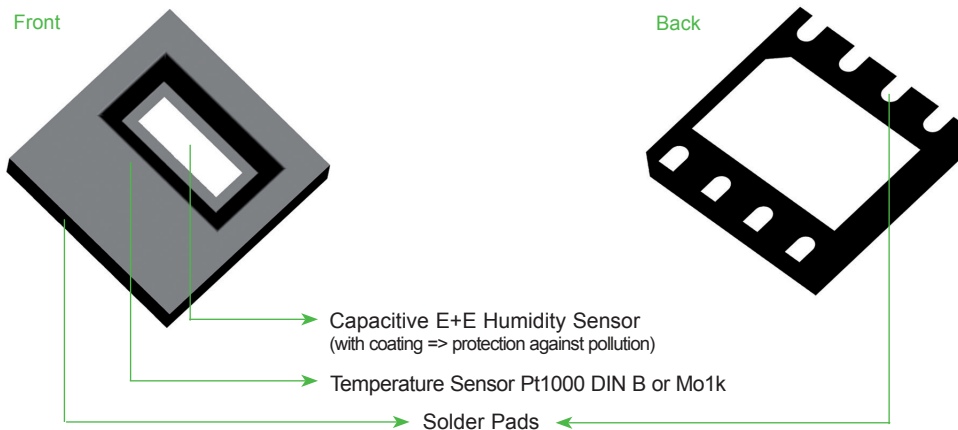

Accuracy for rH and T

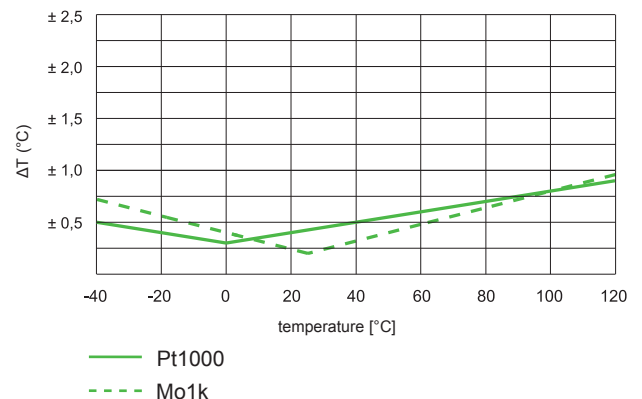
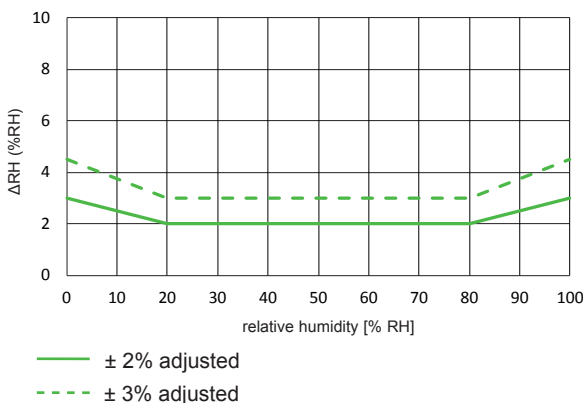

Technical Data

Humidity Element

Working range	humidity:	0...100% RH	
	temperature:	-40...140°C (-40...284°F)	
Nominal capacitance	C_0	70 pF	
Accuracy RH at 30°C	HCT01-00:	non adjusted (C_0 : 70±7 pF)	
	HCT01-02:	±2% RH (20...80% RH)	±3% RH (0...90% RH)
	HCT01-03:	±3% RH (20...80% RH)	±4.5% RH (0...90% RH)

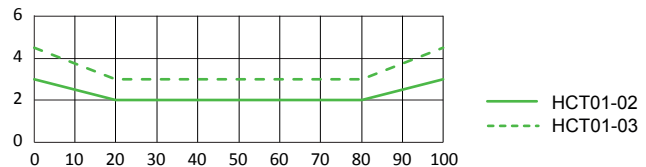

Sensitivity	0.25 pF / % RH
Temperature dependence ¹⁾	$dC = -0,00083 * RH(T-30°C) [pF]$
Hysteresis	< 1.85%
Long term stability	drift < 0.5% / year ²⁾
Maximum supply voltage (no DC voltage)	5V max (U _{pp})
Maximum DC voltage	< 0.3V
Parallel Resistance	$R_p \geq 100 M\Omega$
Serial Resistance	$R_s \leq 1200 \Omega$
Response time	$t_{63} \leq 6s$
Material housing	plated Cu lead-frame and green epoxy-based compound fully RoHS and WEEE compliant
Lead finish	NiPdAu
Sensor protection	E+E coating
Storage temperature	-40...55°C (-40...131°F)
Dimensions	5x5x0.95 mm
Packaging	tape and reel

Temperature Element	Mo1k	Pt1000
Nominal resistance (at 25°C / 77°F)	$R_{25} = 1000 \text{ Ohm}$	$R_0 = 1000 \text{ Ohm}$
Accuracy	$dt = \pm[0.2+0.008 * (t-25)] \text{ K}$	DINB
Response time	$t_{63} \leq 6s$	
Characteristics	$R = R_0 * (1+A*t+B*t^2)$ $R_0 = 928.73 \text{ Ohm}$ $A = 0.0030659$ $B = 3.41*10^{-7}$	acc. EN60751
Maximum continuous current ($t_{LL} < t_A < t_{UL}$)	0.1mA (I_{cont})	
Maximum current	1mA (I_{max})	
Self heating	0.35 K/mW	

1) Detailed calculation on request.
2) In environments with high concentrations of volatile organic compounds, the value may be higher.

Working Range

The working range is shown with regard to the humidity / temperature limits.

Although the sensors would not fail beyond the limits, the specification is guaranteed only within the working range.

In applications with high humidity at high temperatures the time factor shall be considered.

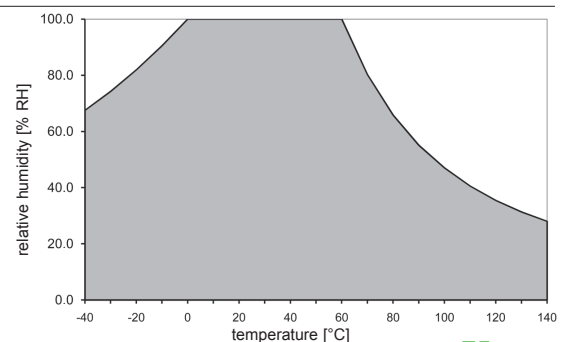

Characteristic Humidity Element

The average increase of capacitance over the working range is app. 25 pF. For the range of 0–98% RH linear approximation is possible, errors will be lower than $\pm 1.5\%$ RH.

The sensor characteristic is determined by the following linear formula:

$$C(U_w) = C_0 * [1 + HC_0 * U_w] \quad C_0 = 70 \text{ pF}$$

with $HC_0 = 3420 \pm 191 \text{ ppm / \% RH}$

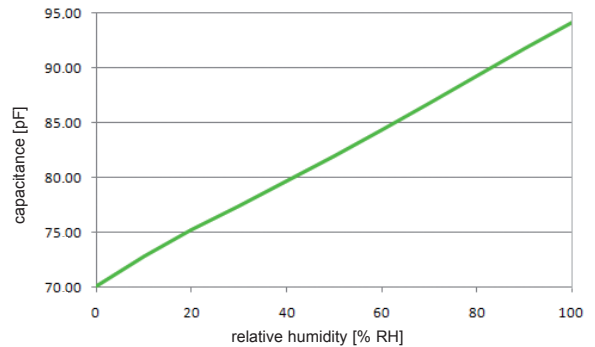

For high accuracy requirements, the sensitivity is determined by the following polynomial:

$$C(U_w) = C_0 * [1 + HC_0 * U_w + k(U_w)]$$

whereby:

$$k(U_w) = A_1 * U_w + A_2 * U_w^{1.5} + A_3 * U_w^2 + A_4 * U_w^{2.5}$$

$$A_1 = 2.6657E^{-3} \quad A_2 = -9.6134E^{-4}$$

$$A_3 = 1.1272E^{-4} \quad A_4 = -4.3E^{-6}$$

Connection Diagram

Top View:

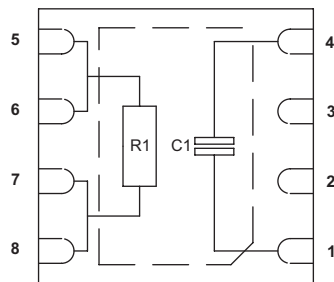

1	H1	Humidity +
2	NC	not connected
3	NC	not connected
4	H2	Humidity -
5	T1	Temperature
6	T1	Temperature
7	T2	Temperature
8	T2	Temperature

Dimensions in mm

DFN-8 package

Top View:

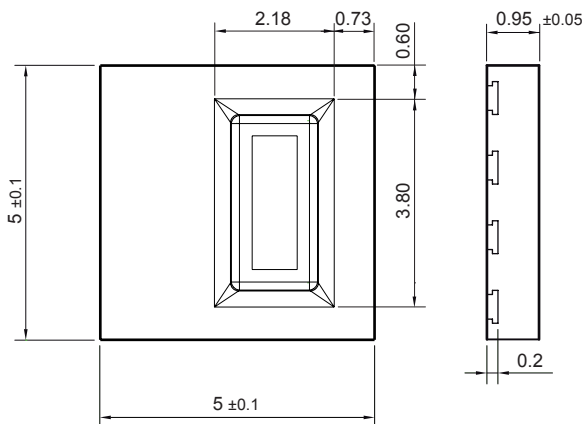

Bottom View:

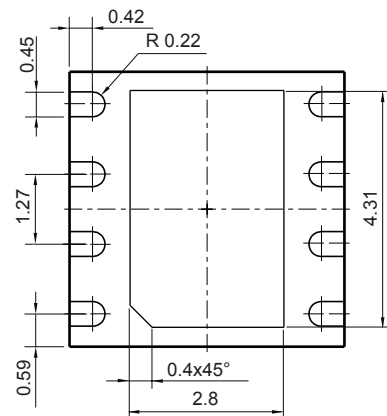

Possible circuitries using HCT01

Depending on accuracy requirements and existing electronics, various cost-effective evaluation circuits are available – our specialists can provide expert advice for your specific application.

Ordering Guide

TYPE	ACCURACY RH	TEMPERATURE ELEMENT	PACKAGING
HCT01 (HCT01)	non adjusted (00) ±2% (02) ±3% (03)	no temperature element (no code) Pt1000 DINB (D) Mo1k (S)	1000 sensors per reel (TR1) 2500 sensors per reel (TR2,5)

Order Example

HCT01-02STR1

Type: HCT01
 Accuracy RH: ±2%
 Temp. Element: Mo1k
 Packaging: 1000 sensors per reel